



**07 & UP 4WD GM 1500 3.5" FRT
 1.75" REAR LIFT KIT**

Thank you for choosing Rough Country for your suspension needs.

Rough Country recommends a certified technician install this system. In addition to these instructions, professional knowledge of disassemble/reassembly procedures as well as post installation checks must be known. Attempts to install this system without this knowledge and expertise may jeopardize the integrity and/or operating safety of the vehicle.

Please read instructions before beginning installation. Check the kit hardware against the parts list on the rear cover of these instructions. Be sure you have all needed parts and know where they go. Also please review tools needed list and make sure you have needed tools.

PRODUCT USE INFORMATION

As a general rule, the taller a vehicle is, the easier it will roll. Seat belts and shoulder harnesses should be worn at all times. Avoid situations where a side rollover may occur.

Generally, braking performance and capability are decreased when larger/heavier tires and wheels are used. Take this into consideration while driving. Do not add, alter, or fabricate any factory or after-market parts to increase vehicle height over the intended height of the Rough Country product purchased. Mixing component brands is not recommended.

Rough Country makes no claims regarding lifting devices and excludes any and all implied claims. We will not be responsible for any product that is altered. If question exist we will be happy to answer any questions concerning the design, function, and correct use of our products.

This kit does not fit vehicles equipped with electric power steering.

This kit is packaged as a leveling kit—raising the front 3.5" and the back 1.75". If you desire a different look or if the vehicle has a tool box or added weight in the rear, please consult with your sales representative about other block and u-bolt options.

This suspension system was developed using a 32 x 11.5 tire with factory wheels. Examples of tire sizes that can be used are 285/75R17, 285/65R18, or 285/55R20. **Note** if wider tires are used, offset wheels will be required and trimming may be required.

NOTICE TO DEALER AND VEHICLE OWNER

Any vehicle equipped with any Rough Country product should have a "Warning to Driver" decal installed on the inside of the windshield or on the vehicle's dash. The decal should act as a constant reminder for whoever is operating the vehicle of its unique handling characteristics.

Tools Needed:

- 18MM Wrench
- 15MM Wrench
- 21MM Wrench
- 11MM Wrench
- 10MM Wrench
- Floor Jack
- Jack stands
- Thread Locker

Torque Specs:

Size	Grade 5	Grade 8
5/16"	15 ft/lbs	20 ft/lbs
3/8"	30 ft/lbs	35 ft/lbs
7/16"	45 ft/lbs	60 ft/lbs
1/2"	65 ft/lbs	90 ft/lbs
9/16"	95 ft/lbs	130 ft/lbs
5/8"	135 ft/lbs	175 ft/lbs
3/4"	185 ft/lbs	280 ft/lbs
	Class 8.8	Class 10.9
6MM	5 ft/lbs	9 ft/lbs
8MM	18ft/lbs	23 ft/lbs
10MM	32ft/lbs	45ft/lbs
12MM	50ft/lbs	75ft/lbs
14MM	85ft/lbs	120ft/lbs
16MM	130ft/lbs	165ft/lbs
18MM	170ft/lbs	240ft/lbs

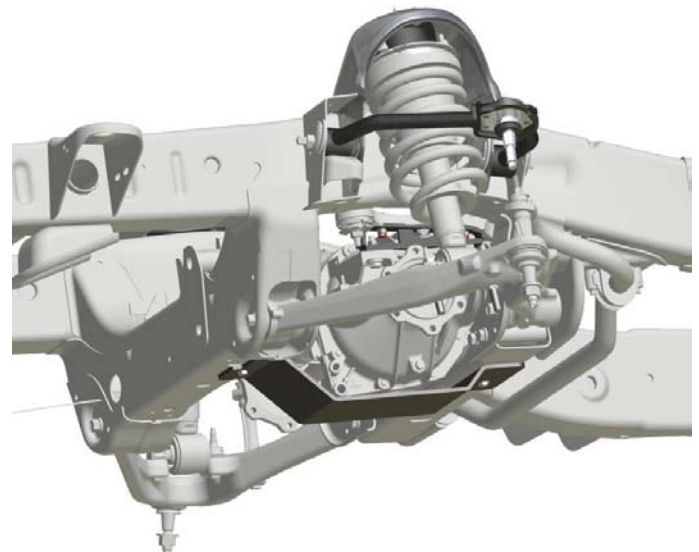

FRONT INSTALLATION

1. Park the vehicle on a level surface and chock the rear wheels.
2. Jack up the front of the vehicle. Place jack stands under the frame rails and lower onto jack stands letting the front suspension hang.
3. Remove the tires and wheels. Remove the upper and lower factory skid plates using a 15mm wrench. Retain factory hardware and front skid plate for reuse.
4. Using a 21mm wrench, remove the tie-rod nut as shown in **Photo 1**. Strike the side of the mount to dislodge the tie rod end. Remove from the knuckle.
5. Remove the sensor wire from the plastic clip. Remove the bracket from the control arm using a 10mm wrench. See **Photo 2**.

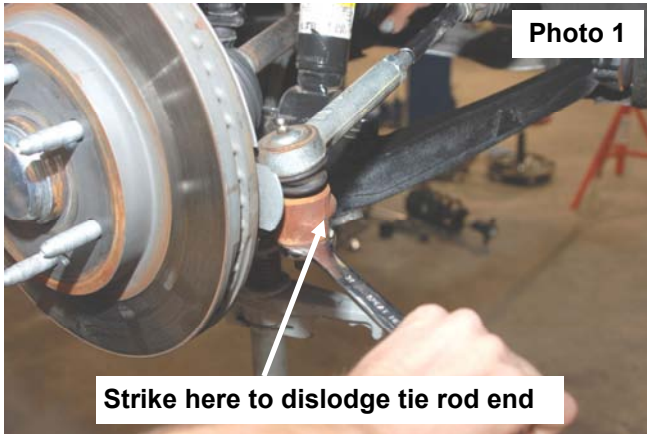

6. Remove and unplug the ABS sensor wire from the frame as shown in **Photo 3**.
7. Remove the upper ball joint nut using a 18mm wrench. See **Photo 4**. Strike the knuckle as shown to dislodge the ball joint. Separate the upper control arm from the knuckle.

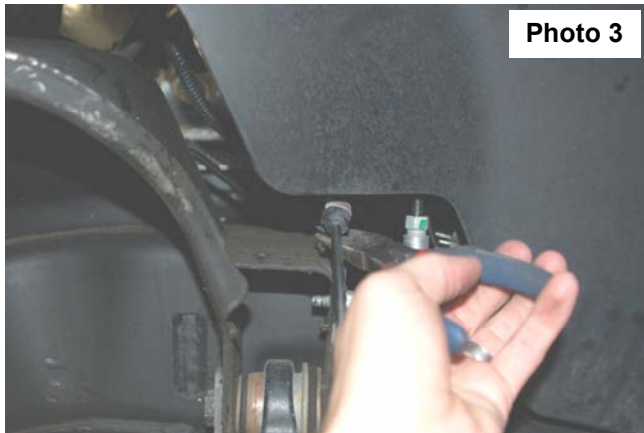

8. Using a 18mm wrench, remove the upper strut nuts as shown in **Photo 5**. Retain factory hardware for reuse.
9. Using a 15mm wrench, remove the 2 bolts securing the lower strut mount to the lower control arm and remove the strut from the vehicle. Remove and discard the factory lower retainer clips. New hardware will be used. See **Photo 6**.

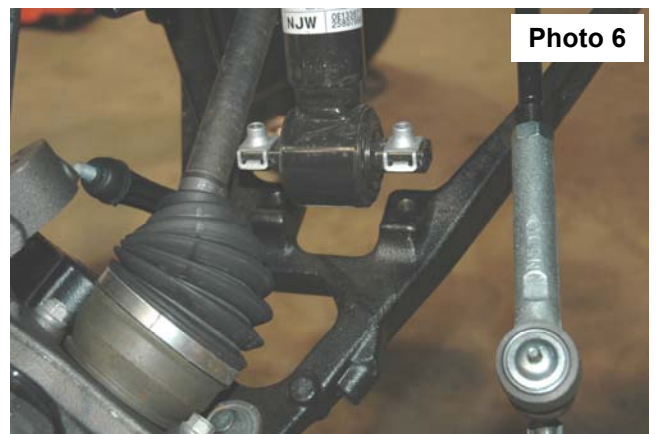

10. Mark location of alignment cams on upper control arms to allow installation of new arm to same position. Using a 21mm wrench and 21mm socket, remove the upper control arms from the vehicle. **See Photo 7**. Retain the hardware
11. Using a 11mm wrench, remove the drive shaft bolts. **See Photo 8**. Retain hardware for reuse.



Photo 7

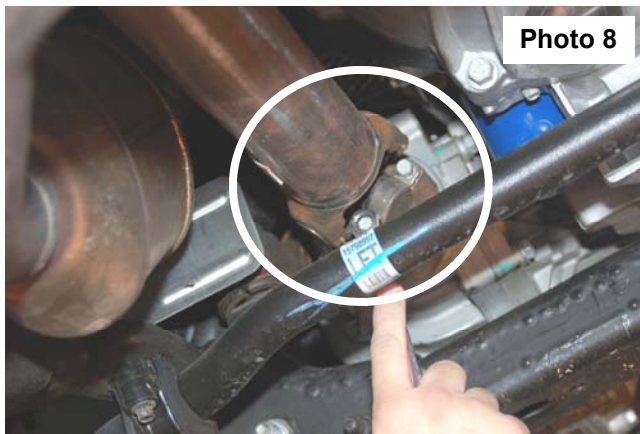

Photo 8

12. Place a floor jack under the differential assembly to provide support for following steps.
13. Using a 15mm wrench, remove the 6 axle shaft bolts and secure axle shafts out of the way. **See Photo 9** Repeat on opposite side. Retain the factory hardware for reuse. Unplug the electrical connector on differential as shown in **Photo 10** and unplug the diff vent hose. **Photo 11**
14. Using a 18mm socket remove the 4 differential bolts (2 each side) securing the differential to the frame. **See Photo 9**.
15. Slowly lower differential assembly to the ground.
16. Using a hand grinder. Grind away marked portion of the cooling fin as shown in **Photo 12** and **Photo 13**. Grind until flush with casing.



Photo 9

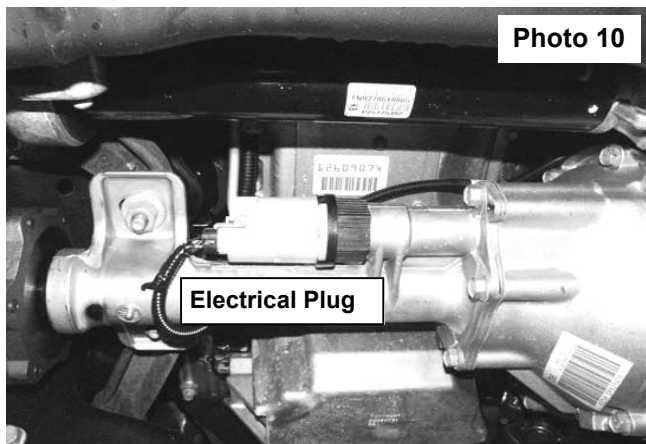

Photo 10

Electrical Plug

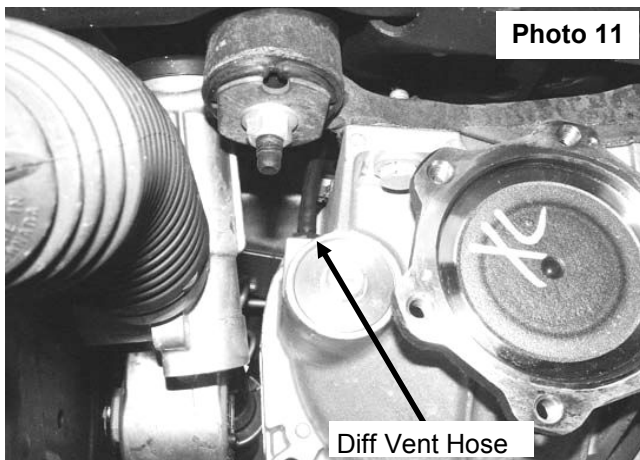

Photo 11

Diff Vent Hose

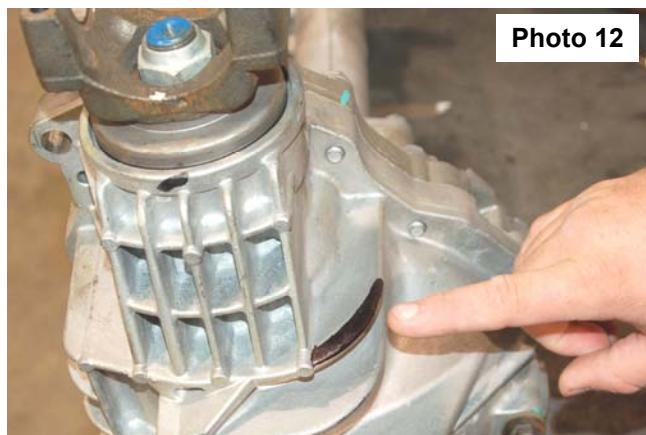
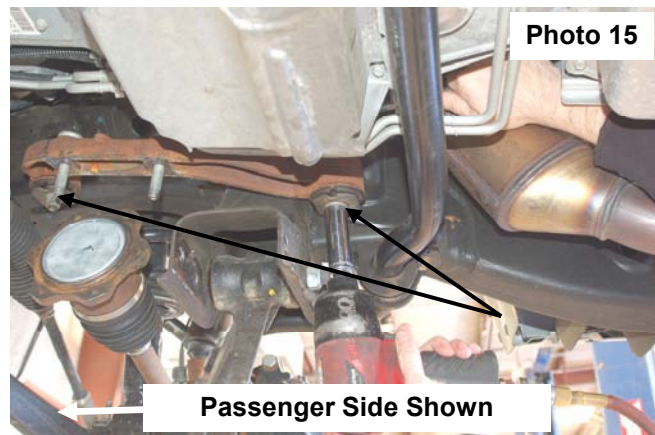
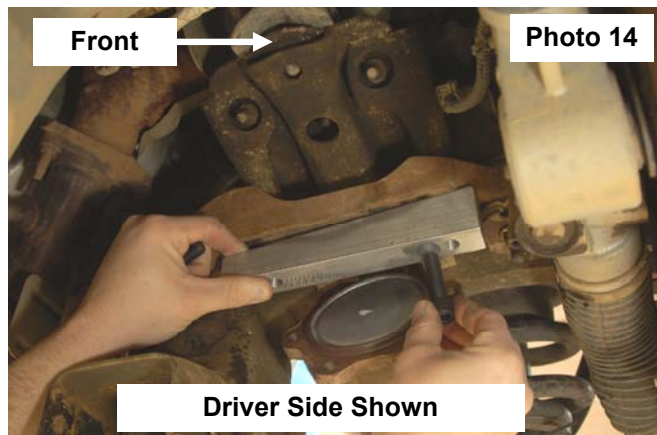

Photo 12

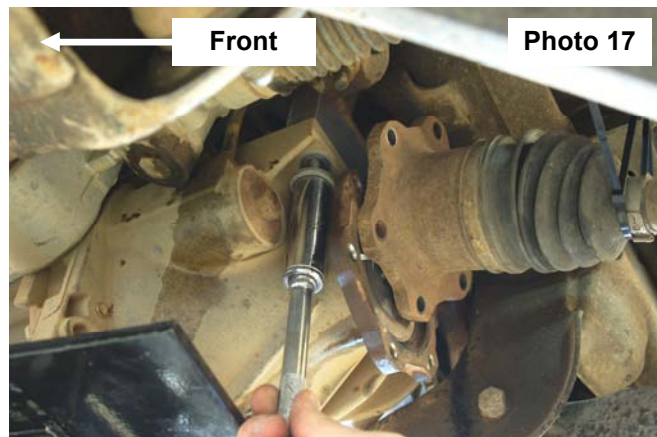

Photo 13

17. On the Drivers side, locate and secure the new diff mount drop bracket to the stock location using the supplied 12mm x 45mm socket head bolts. Tighten using a 10mm Allen head. **Note that the narrower diff drop bracket will install on the driver side of the vehicle with the taller part to the front. See Photo 14.**
18. Remove the stock differential bracket on the passenger side using a 18mm & 15mm socket / wrench. **See Photo 15.**



19. Remove the factory studs using a hammer and then reinstall the factory mount. Tighten using a 18mm & 15mm wrench
20. Install the supplied diff bracket to the stock mount as shown in **Photo 16** with the supplied 12mm x 70mm socket head bolts & 12mm lock nuts. Make sure the taller end of the bracket is to the front. Tighten using a 18mm socket/ wrench.
21. Using the supplied 12mm x 80mm long set screw, insert them into the new diff mount as seen in Photo 16. Tighten with a 10mm allen wrench.



22. Reinstall the differential to the Rough Country diff drop brackets with the factory bolts on the drive side and factory nuts on the passenger side. Tighten using a 18mm socket.
23. Reconnect the connector plug on the differential & pull the vent hose down slightly and reinstall on the differential. The differential vent hose may be tapped to the electrical loom. If so separate and slightly pull for slack.
24. Reinstall the axle shafts to the differential with the factory hardware using a 15mm socket as removed in Step 15.
25. Install the new control arm as shown in **Photo 18** in the factory mount making sure the 1/4" stud for mounting the brake line bracket is toward the rear with the factory hardware. Tighten using mark made as a reference in Step 10 and using a 21mm wrench & socket. **Passenger side shown.**
26. Locate the supplied strut spacer and install the supplied 3/8" stud extensions. Using a 9/16" socket snug self clinching stud in the new spacer as shown in **Photo 19**. **The stud should clinch with about 35-45 ft/lbs of torque. Do not over torque the nut.**



27. Install the strut spacer on the factory strut with factory hardware and using a 18mm wrench. **See Photo 20.**
28. Install the strut assembly in the factory mount with the supplied 3/8" nuts/washers & lock-washers on the upper mount. Tighten using a 9/16" wrench. **Note: Flat washer must be installed on studs. See Photo 21.**

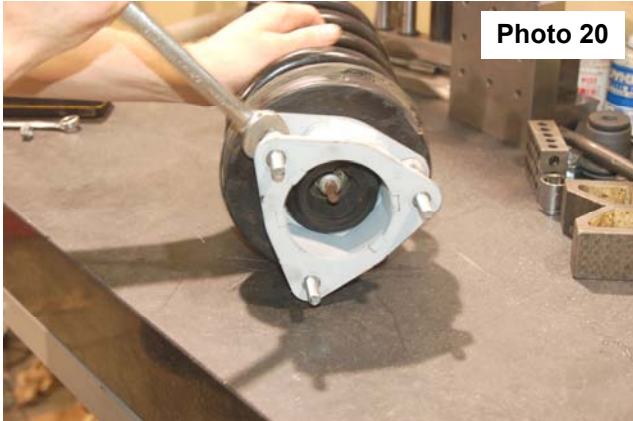

Photo 20

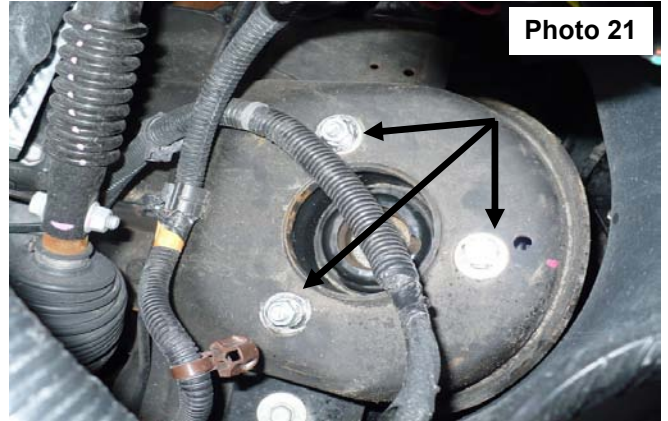

Photo 21

29. Install the strut in the lower control arm using the supplied 3/8" 2 1/4" bolts /washers & nuts using a 9/16" wrench. **See Photo 22.** It may be necessary to jack up the lower control arm with a floor jack to align lower strut holes.
32. Reinstall the sway bar on the lower control arm using a 15mm wrench.
33. Reinstall the knuckle to the upper control arm with the supplied castle nuts/cotter pins. Tighten using 3/4" wrench to **50 ft/lbs. DO NOT OVER-TORQUE THE CASTLE NUT.** Reinstall the tie rod end into the knuckle with factory hardware and using a 21mm wrench.
34. Reinstall the driveshaft with the factory hardware using a 11mm wrench.
35. Install the brake line bracket on the new control arm with the supplied 1/4" lock nut / washer and using a 7/16" wrench. **See Photo 23. Driver side shown.**



Photo 22



Photo 23

36. Reconnect the ABS wire that was disconnected in Step 6.
37. Locate and install the new lower skid plate below the differential in the factory location (if equipped) with the factory hardware and using a 15mm wrench. **See Photo 24.** If not equipped with a factory skid plate, use the supplied 3/8" self tapping bolts to install the skid plate in the holes in cross-member.
38. Reinstall the wheels/tires.
39. Jack up the vehicle and remove the jack stands.
40. Lower the vehicle to the ground.



Photo 24

REAR INSTALLATION

1. Chock the front wheels.
2. Place a floor jack under the differential and jack up the rear of the vehicle.
3. Place jack stands under the frame rails and lower onto the jack stands.
4. Remove the tires/wheels.
5. Remove the factory shock absorbers using a 21mm wrench & socket. Retain the factory hardware for reuse.
6. Remove the factory u-bolts using a 21mm socket, then remove the factory blocks. Lower the axle using the floor jack to allow for the new 3" block to be installed.

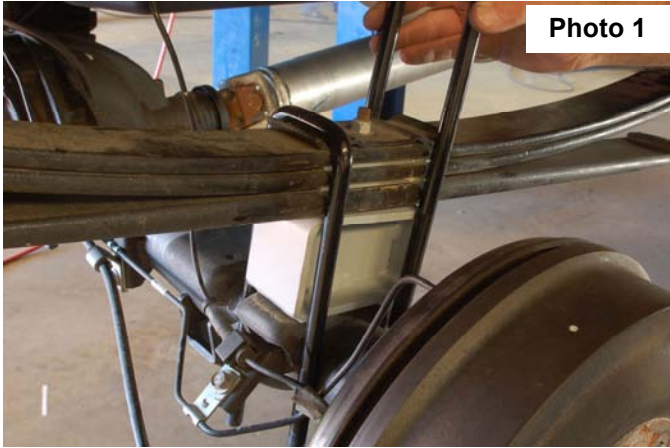

7. Install the block on the factory spring pad with the flat part of the block on the spring and the thinner end towards the front. Jack up the axle to meet the springs, making sure to align the center pin. **See Photo 1**
8. With the floor jack applying slight pressure to the rear axle to keep the pin aligned, install the new supplied u-bolts and tighten in a crossing pattern, using a 7/8" socket.
9. Locate the new shock absorbers part # 658726, and install the shock absorbers in the factory mounting locations using the factory hardware. Tighten using a 21mm wrench & socket. **See Photo 2**
10. Install the tires/wheels.
11. Jack up the vehicle to remove the jack stands. Remove the jack stands and lower the vehicle to the ground.

POST INSTALLATION INSTRUCTIONS

1. Lightly grease the ball joints. Do not over grease the ball joint as this could cause ball joint boot failure.
2. Have a qualified alignment center align the vehicle immediately.
3. Have headlights adjusted to proper settings.
4. Wheels must be retighten at 50 miles.
5. All kit components must be retightened at 500 miles and then every three thousand miles after installation. Periodically check hardware for tightness.
6. Install "Warning to Driver" decal on sun visor.
7. On some vehicles the front lower skirting will need to be trimmed if using certain wheel /tire combinations and with heavy offset wheels. Trim only as needed.

Box Kit

**1-Driver Side Control Arm
1-Pass Side Control Arm
1-Driver Side Diff Bracket
1-Pass Side Diff Bracket
1-Diff Lower Skid Plate
2-Strut Spacers
4-9/16" x 10 1/2" U-bolts
2-3" spacer blocks
2-Rear Shock Absorbers**

Kit Poly Bag

**1-12mm x 45mm Socket head Bolt
1-12mm x 70mm Socket head Bolt
2-12mm x 80mm Set Screws
4-3/8" x 2 1/4 bolts
8-3/8" washers
4-3/8" lock nuts
2-1/4" nut
6-3/8" Studs
6-3/8" Lock Washers
6-3/8" Flat Washers
6-3/8" Nuts
2-3/8 self tapping bolts**

KIT CONTENT



Thank you for choosing Rough Country for your suspension needs.



07-11 GM 4WD 1500 P/U 1 1/4" Body Lift

Thank you for choosing Rough Country for all your suspension needs.

Rough Country recommends a certified technician install this kit. Attempts to install this kit without this knowledge and expertise may jeopardize the integrity and/or operating safety of the vehicle. Please read instructions before beginning installation. Check the kit hardware against the kit contents list page. Be sure you have all needed parts and know where they go. Review tools needed list and make sure you have the tools needed to install the kit.

PRODUCT USE INFORMATION

We will not be responsible for any product that is altered. We will be happy to answer any questions concerning the design, function, and use of our products by calling 800-222-7023.

Kit was designed for use with both standard cab and 4 door models. Standard cabs will not utilize all cab mount spacers. Standard cabs only will use the cab strap extension brackets.

This body lift was developed using a 33x12.5x20 tire with factory wheels. Combo kits are available. Ask your Rough Country Dealer for more info.

NOTICE TO DEALER AND VEHICLE OWNER

Any vehicle equipped with any Rough Country product should have a "Warning to Driver" decal installed on the inside of the windshield or on the vehicle's dash. The decal should act as a constant reminder of the vehicles unique handling characteristics. These instructions should be kept in the vehicle for its service life.

Kit Contents:

2-Fr Bumper Outer Relocation Brackets
 2-Fr Bumper Frame Brackets
 8-1 1/4" X 3" Cab Spacers
 8-1 1/4" X 2" Bed Spacers
 2-Standard Cab Strap Ext.

RC701BAG Containing:

For Front Cab Mounts:

14mmx 140mm Bolts (6)
 12mm x 140mm Bolts (2)

For Front Bumper Brackets:

3/8" x 1" Bolts (4)
 3/8" Flat Washers (4)
 3/8" Lock Nuts (4)

For Bed Mounts:

12mm x 65mm Bolt (6)

For Rear Bumper:

10MM Nut (2)
 1-1/4" Tall X 2' 9/16" ID Pucks (2)
 1" Tall X 2" Body Pucks (2)
 14mm x 60mm Bolts (4)

For Ground Wire Extension:

1/4" x 3/4" Bolt (1)
 1/4" Flat Washer (2)
 1/4" Lock Nut (1)

For Strap Extension:

12mm x 35mm Bolts (2)
 12mm Flange Lock (2)
 1/2" Flat Washer (2)

Tools Needed:

Jack	8mm Socket
Jack Stands	10mm Socket / Wrench
Wood Blocks (2x4)	14mm Socket / Wrench
Pliers	13mm Socket / Wrench
Hammer	15mm Socket / Wrench
Phillips Screwdriver	16mm Socket / Wrench
Drill Motor	18mm Socket / Wrench
1/2" Drill Bit	19mm Socket / Wrench
Reciprocating Saw	21mm Socket / Wrench
Clamp	22mm Socket / Wrench
	Hand Grinder



CAB INSTALLATION INSTRUCTIONS

1. **Raise hood disconnect positive and negative battery cable from the battery using 10mm wrench.** This is done to prevent accidental airbag deployment. Check owners manual and remove airbag fuses to prevent accidental air bag deployment.
2. Remove the eight plastic clips from the radiator bezel using a screwdriver and remove bezel. Retain hardware for reuse. **See Photo 1.**
3. Remove 4 bolts from grill using a 10mm socket then pull on lower part of grill to release clips. Retain hardware for reuse. **See Photo 2.**

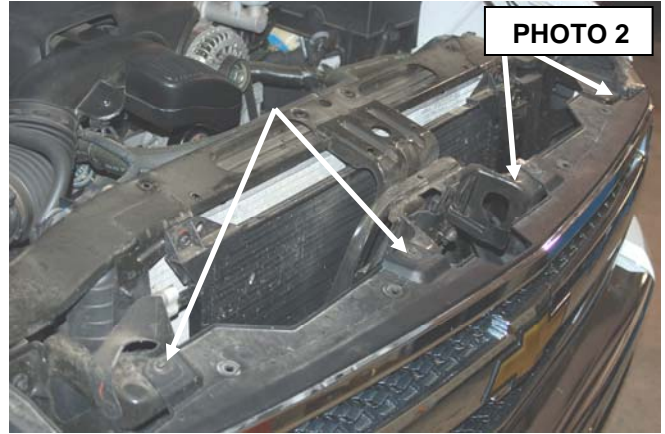
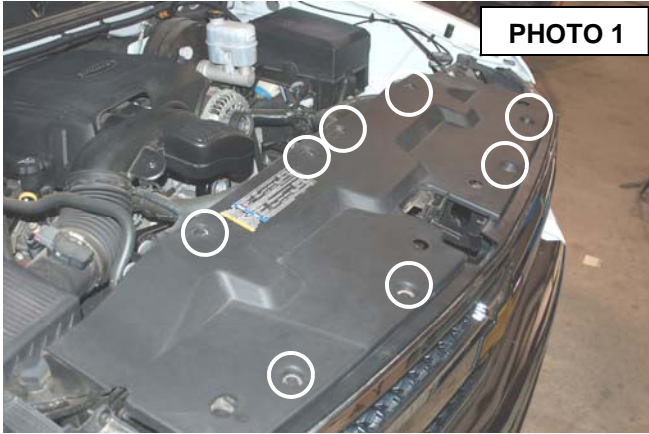

4. Remove four of the clips from the rubber shroud that is attach to the bumper. There are 9 clips total but only 4 need to be removed to remove bumper. Retain hardware for reuse.
5. Unplug fog lights on bumper if equipped.
6. Remove the bumper support brackets located near front body mount that attach bumper to frame using a 15mm socket. **See Photo 3.** Retain hardware for reuse.
7. Remove the two upper bumper bolts using 21mm socket and remove bumper from truck. **See Photo 4.**

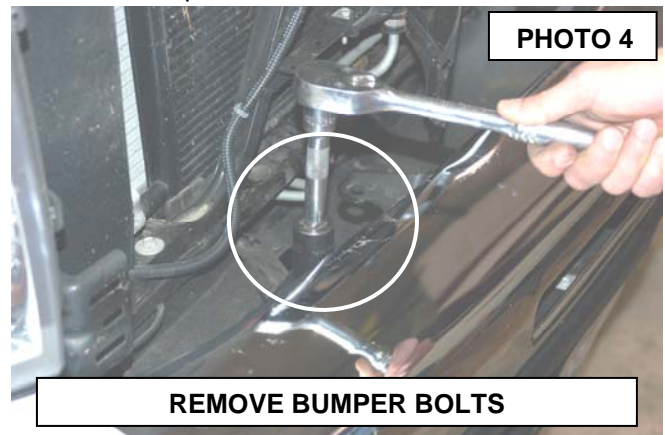
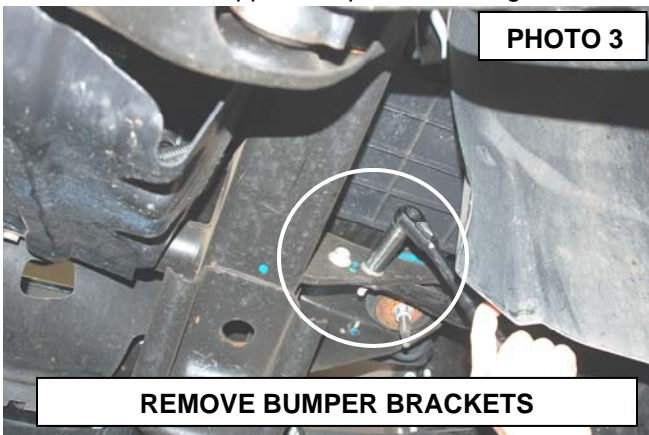

8. Remove ground wire from firewall using 10mm socket. Retain hardware for reuse. **See Photo 5.**
9. Remove both ground wires from frame located on front body mount using 10mm socket / wrench. Retain hardware for reuse. **See Photo 6.**

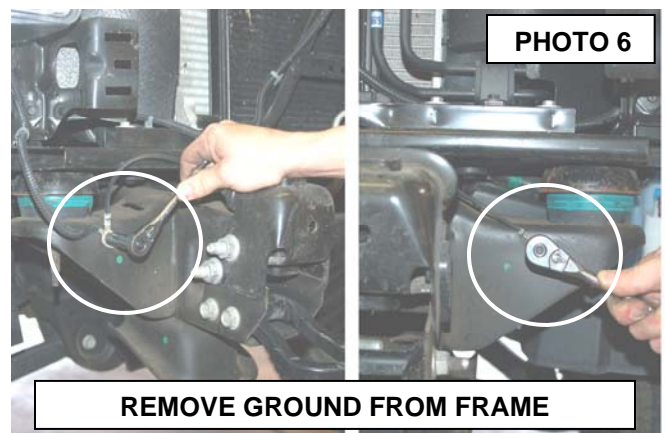

10. Remove upper radiator hose and overflow hose from fan shroud as shown in **Photo 7 & 8**.

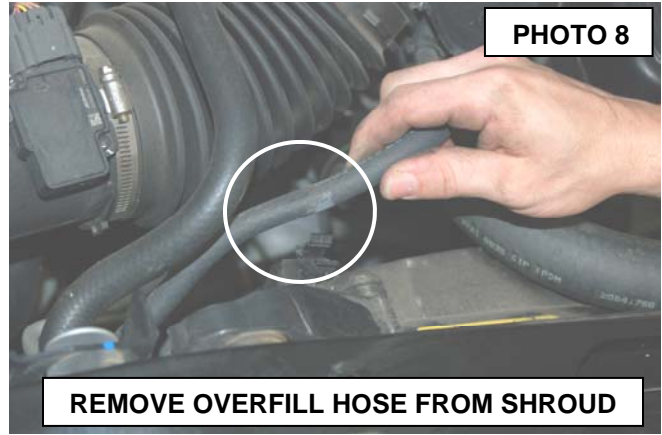

11. Disconnect air intake hose from air box using a Phillips screwdriver and needle nose pliers. **See Photo 9.**

12. Lock steering wheel and mark the location of the upper and lower parts of steering shaft. Remove the shaft bolt using a 15mm socket. **See Photo 10. Do not turn or allow steering to turn while shaft is apart.**

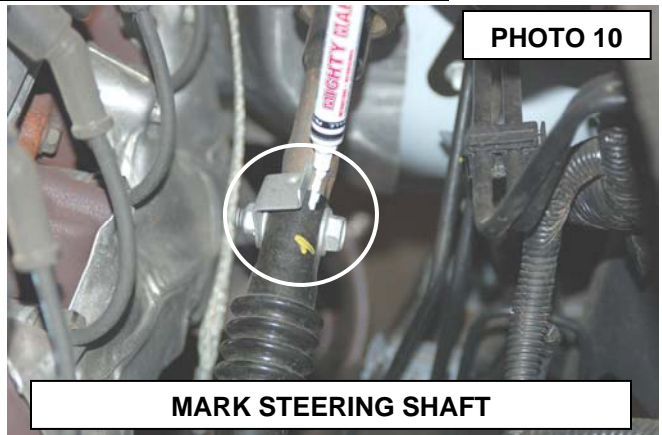

13. Remove starter wire and O2 sensor wire from frame on *passenger side* as shown in **Photo 11** using a 13mm wrench and screwdriver or pliers

14. Remove the four bolt securing the skid plate using a 15mm socket. **See Photo 12.**

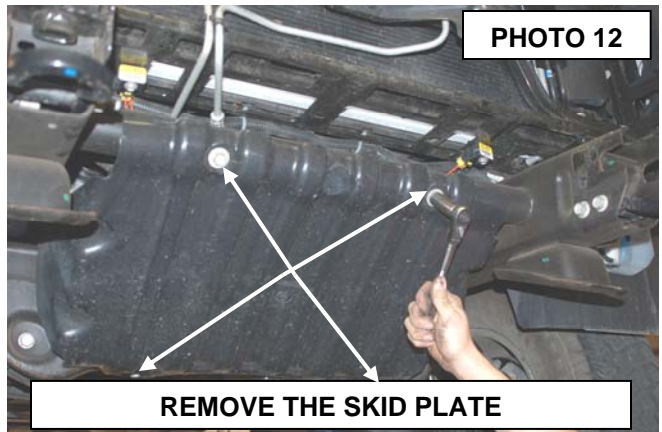

15. Disconnect the emergency brake cable at the connection on the frame below the drivers door by removing the front part of cable from frame just under the front part of driver door. **See Photo 13 & 14.**

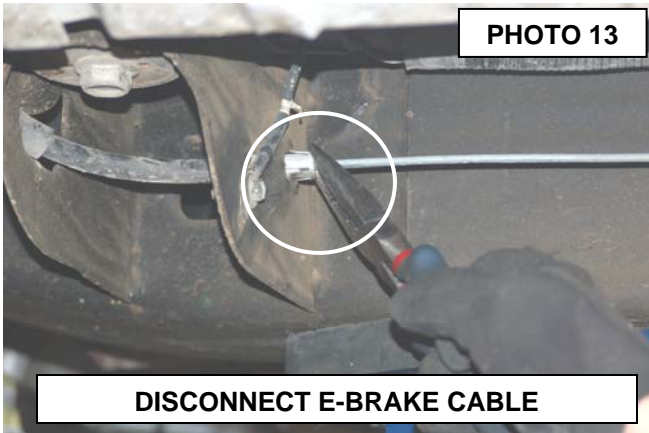

16. Loosen all cab bolts on driver and passenger side using a 15mm & 18mm for both front body mounts as shown in **Photo 15** and 21mm for the other 6 cab mounting points as shown in **Photo 16**. **Remove body mount hardware one side at a time.**

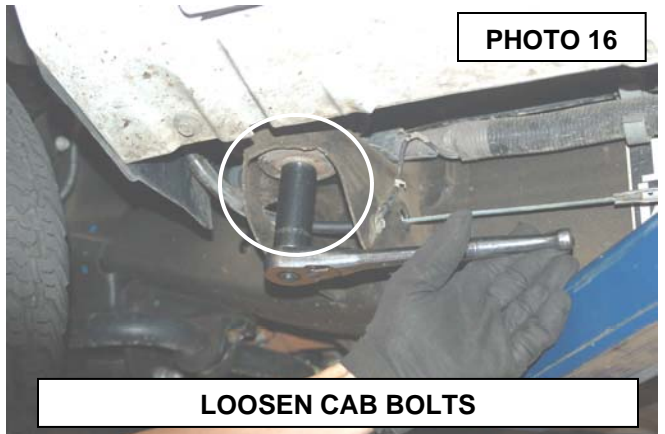
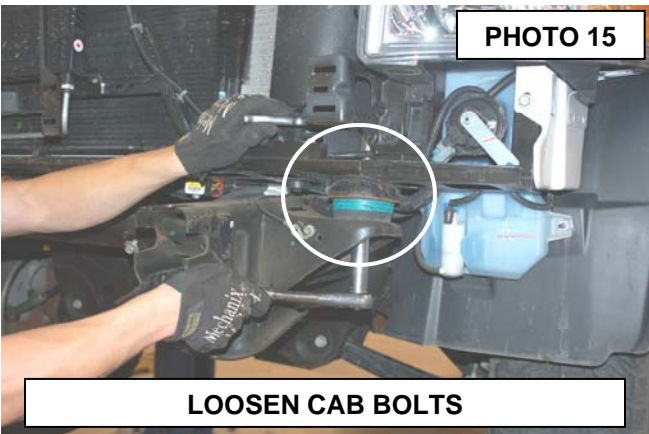

17. **Photo 17** will be removing the cab support strap with a 18mm socket, this is only on a standard cab truck. If you have an extended or crew cab truck please skip this step.

18. Using a jack stand or hydraulic jack with wood blocks slowly lift body from truck. **See Photo 18.**



19. Lift only enough to place body puck on top of body mount. **See Photo 19. Note:** *Passenger side front body mount bolt can be removed by lifting the body bushing out of frame so the bolt will pass by the A/C lines.*
20. Apply thread lock to the three supplied 14x 2.0 x 140mm bolts and install for the 3 body mount on pass side. **See Photo 20.**



21. Apply thread lock to the two supplied 12mmx 1.75 x 140mm bolt and install for the front body mounts. Do not tighten at this time. **Note:** *Install front body mount bolt in same way as it was taken out to clear A/C lines. See Photo 21.*
22. Repeat for Drivers side.

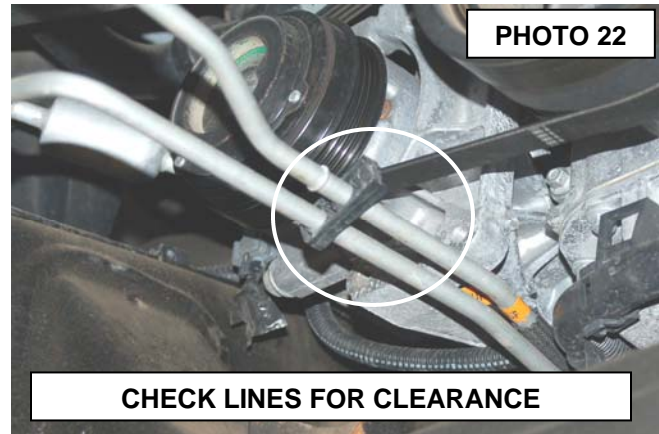
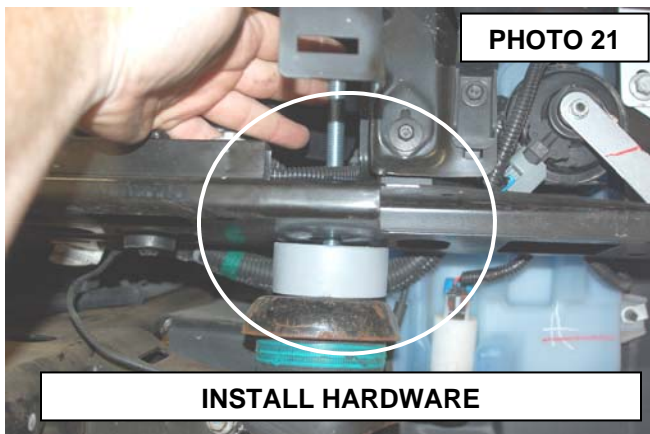

23. Tighten all 14mm bolts to 95ft-lbs using 22mm socket and all 12mm to 65ft-lbs using 18mm socket.
24. Check trans lines make sure the are not rubbing A/C compressor bracket or belt tensioner on some models. Bend lines away if necessary. **See Photo 22 & 23**
25. Reinstall front skid plate with stock hardware and tighten using 15mm socket / wrench to 20 ft-lbs torque.
26. Reconnect engine ground to firewall using supplied ground extension bracket and supplied 1/4" x 3/4" bolt. Tighten with a 11mm socket. **See Photo 24.**
27. Reconnect both front body mount ground wires as previously removed in stock location using a 10mm socket.
28. Reconnect O2 sensor and starter wire to frame on passenger side using a 13mm socket.
29. Reconnect upper and lower parts of steering shaft. Tighten using a 15mm socket to 40 ft-lbs.
30. Reinstall intake hose to airbox and reconnect radiator hose to top of radiator.

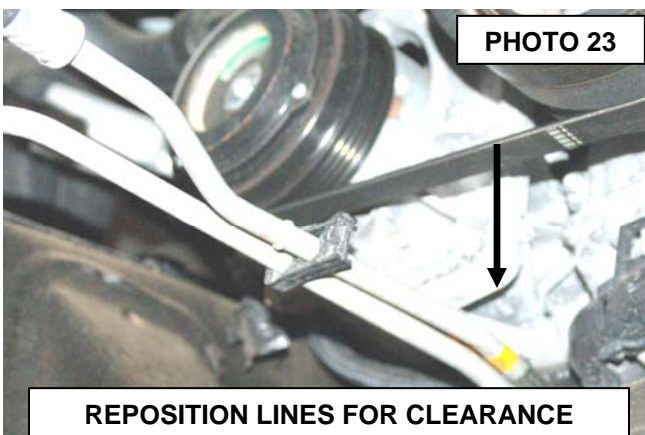

31. Find the tab on driver side body mount where the emergency brake cable runs beside it and bend it up flat with frame to gain slack for cable. **See Photo 25.**
32. Run cable back in its original location and reconnect to rear part of cable. **See Photo 26.**

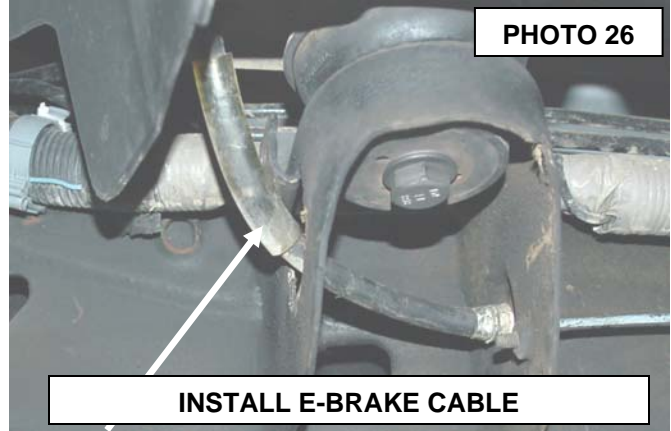

33. Step 33 and 34 are only used on standard cab trucks, attach the factory strap to the bracket with stock bolt and rubber washer and the supplied 12mm flange locknut. Tighten with a 18mm socket and 19mm wrench.
34. Using the supplied 12mm x 35mm long bolt and washer attach the bracket to the factory frame hole. Tighten with a 18mm socket. **See Photo 27**

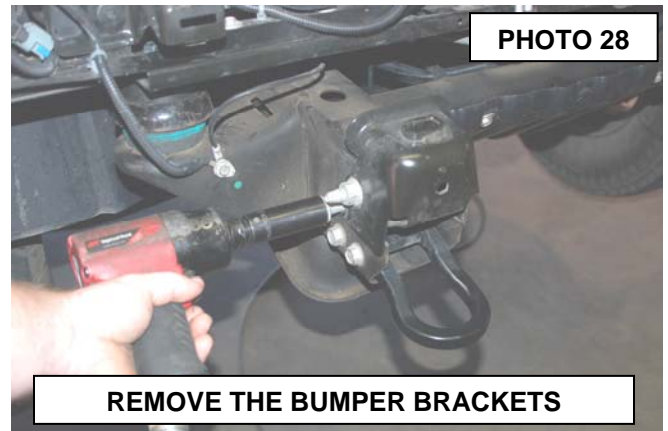
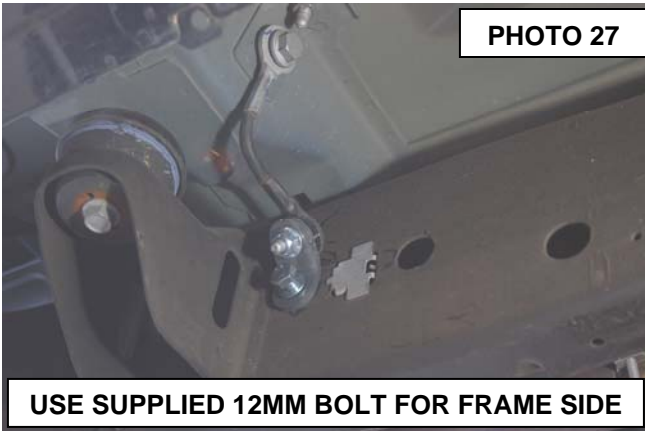

35. Remove the two bolts from driver and pass front bumper brackets using 21mm socket. **See Photo 28.** Retain stock hardware.
36. Mark the front tow hooks as driver and passenger top and remove hardware using 18mm socket. **See Photo 29.** Retain stock hardware.

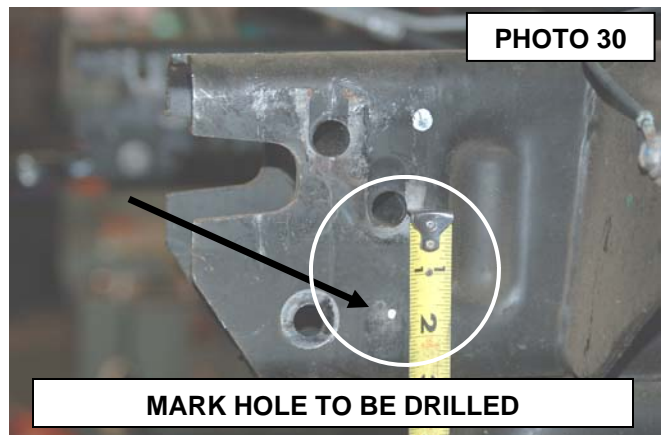
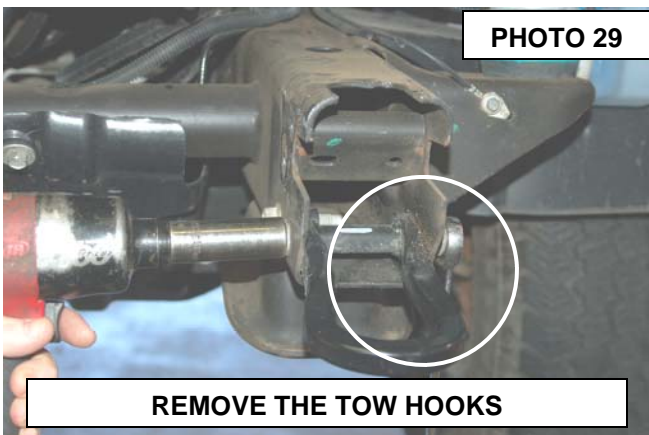

37. Measure 1-7/16" down from second bumper mounting hole and mark. **See Photo 30.** Drill using a 1/2 drill bit. Spray some paint on new hole. Do the same for other side.

- 38. Install tow hooks so that they are upside down and install stock bolts. Tighten to 65ft-lbs using a 18mm wrench / socket. **See Photo 31.**
- 39. Install new front bumper brackets using stock hardware. Adjust bracket up as high as it will go and tighten using

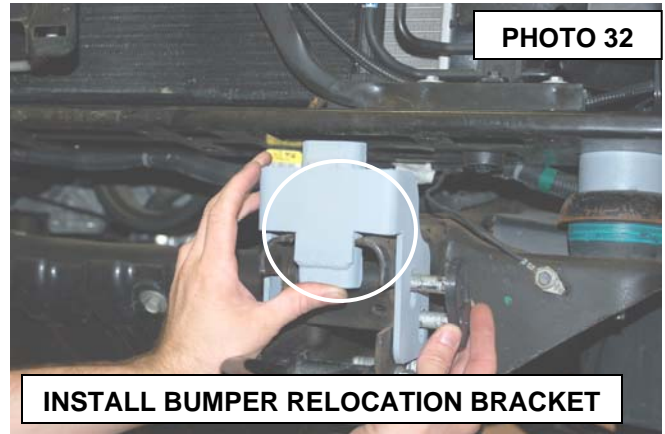

- 21mm socket / wrench. **See Photo 32.**
- 40. Install new lower bumper bracket on driver and passenger with supplied 3/8" x 1" bolts, washers and lock nuts. **See Photo 33.** Do not tighten at this time.

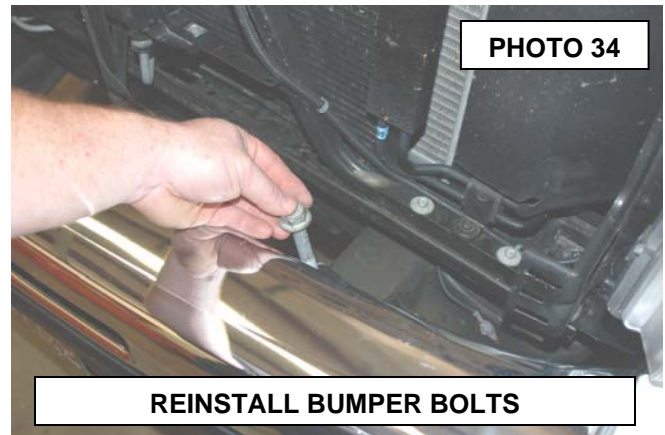
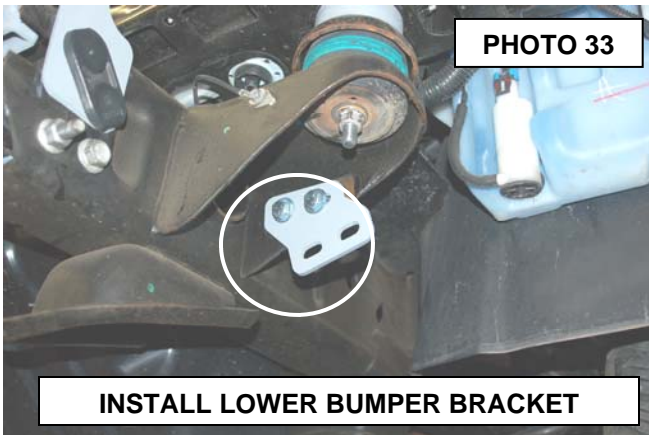

- 41. Install front bumper using stock hardware. Adjust bumper so that it is straight on truck. Tighten hardware with 21mm socket / wrench. **See Photo 34.**
- 42. Install lower bumper brackets using stock bolts. Tighten using a 15mm socket / wrench for stock bolts and 14mm for new bolts. **See Photo 35.**
- 43. Reinstall rubber shroud with stock clips and then install grill using 10mm for stock bolts.
- 44. Reinstall radiator bezel with the stock 8 clips.

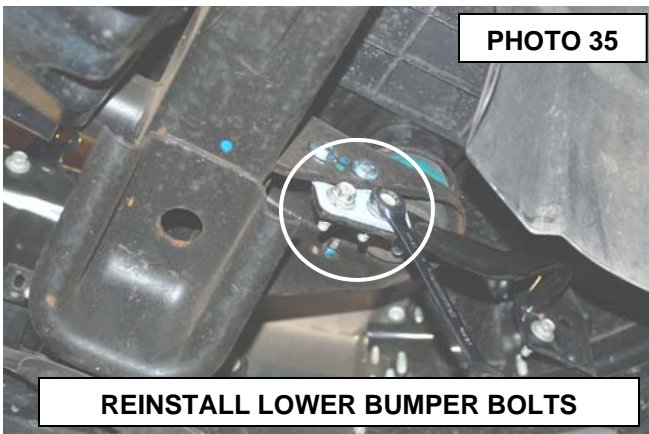

BED INSTALLATION INSTRUCTIONS

1. Unplug the license plate light connector and if equipped the trailer wiring connector. **See Photo 1 & 2.**

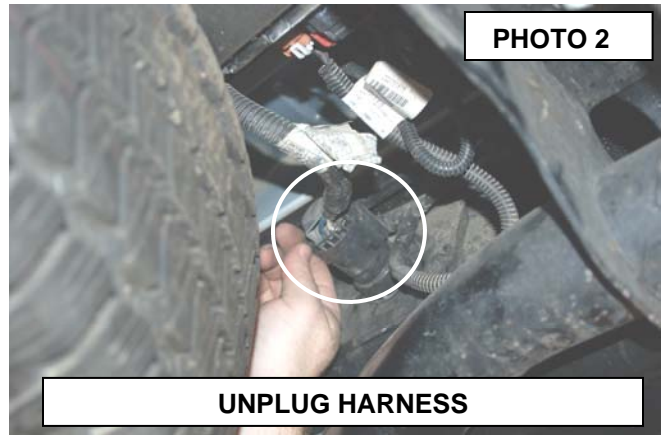
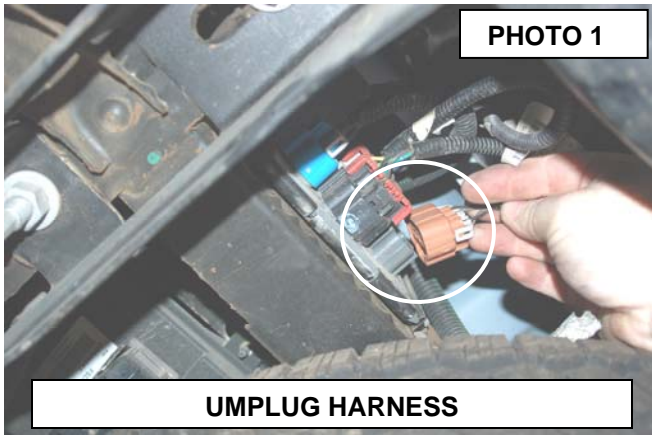

2. Remove the 3 bolts from the driver and passenger side frame as shown in **Photo 3** (Driver Side Shown) that mount the bumper to frame. These six bolts (three per side) are removed using a 18mm and 15mm socket / wrench. Retain the stock hardware.

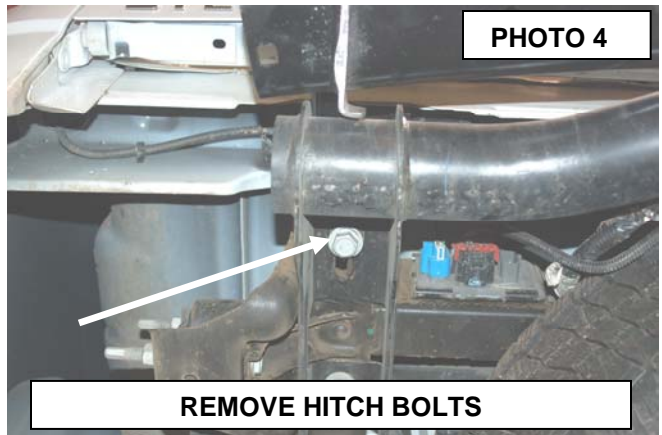
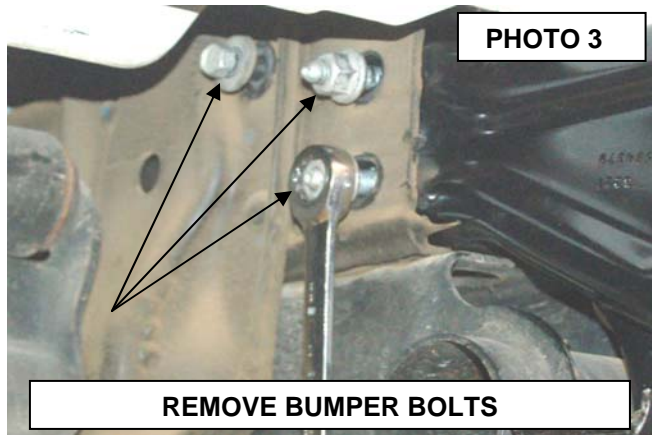

3. Using a 21mm socket remove the 4 bolts located in the receiver hitch. **See Photo 4 & 5.**
4. Remove bumper and set aside.

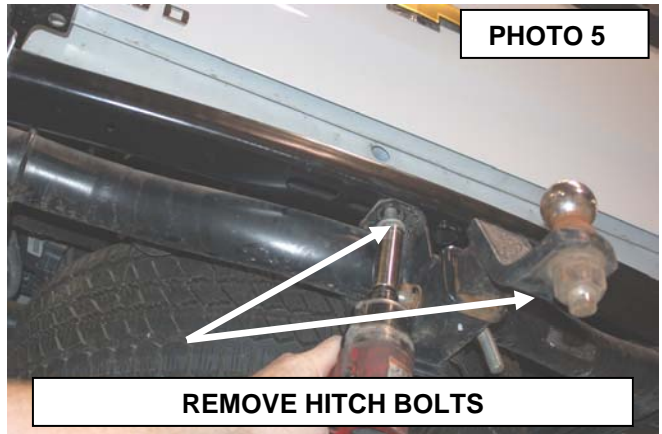

5. Loosen the six bed bolts using 18mm socket but only remove one side at a time. **See Photo 6, 7 & 8.**

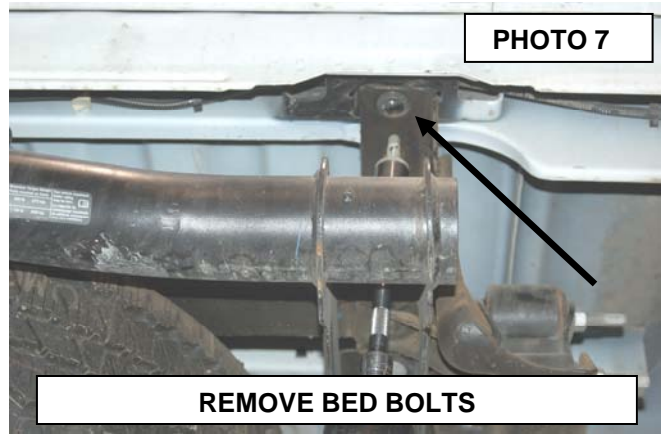

6. With jack stand or hydraulic jack and wood block raise passenger side slowly. **See Photo 9.** Raise bed up enough to install body pucks.

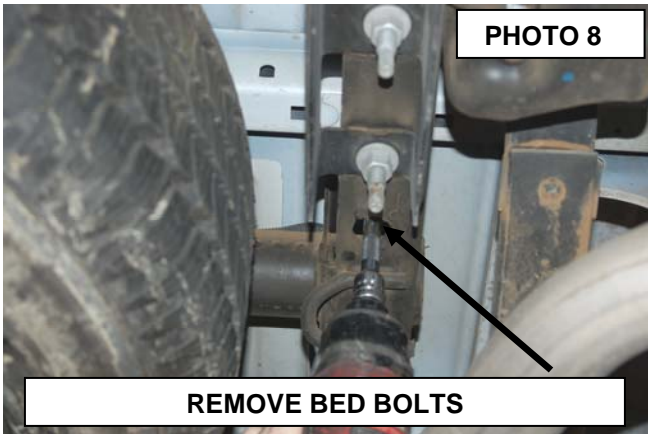

7. Install 4 pucks per side and add lock tight on the supplied 12mmx 65mm bolts / washers and install. Torque to 65 ft/lbs. **NOTE: Make sure fuel filler tube is un-obstructed during lift of driver side.** **See Photo 10, 11 & 12.**

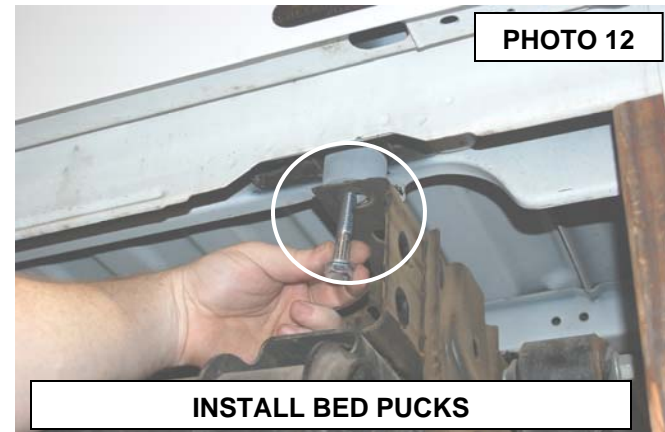
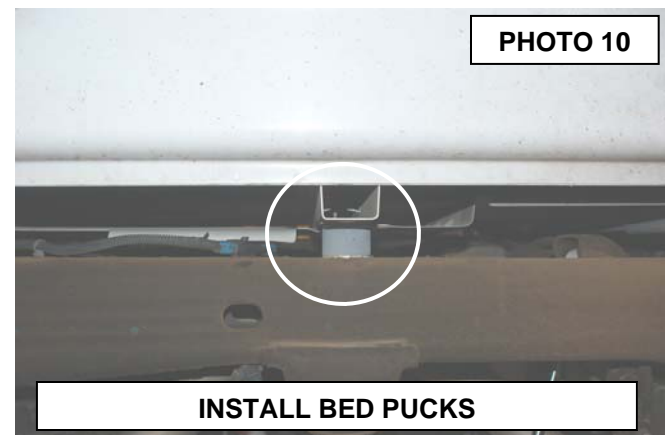

- With bumper still removed, use the supplied template to mark and drill the new holes in the frame. **See Photo 13.**
- Drill the holes using a 1/2" drill bit. **See Photo 14.**

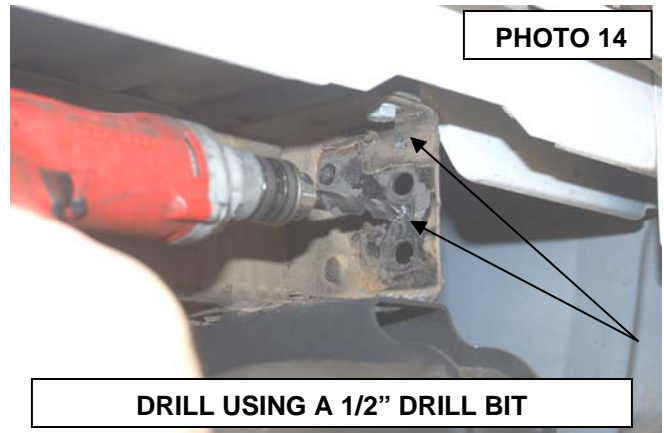

- Reinstall the stock 10mm bolt using the supplied 10mm lock nut back in the frame. Tighten using a 15mm and 17mm wrench. **See Photo 15.**
- Mark and cut the outer mount off of the bumper as shown. Clean and paint the area to prevent rust. **See Photo 16.**



- Photo 17** shows the placement of the hitch pucks with the 9/16" ID holes with the bumper not yet installed. This is just to give you an ideas as to where the pucks will be installed.

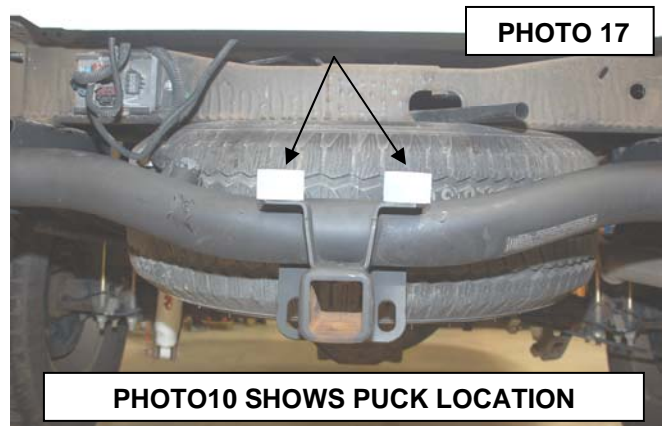

13. Reinstall the factory bolts in the newly drilled holes in the frame. Do not tighten at this time. .
14. Reinstall the bumper on the mounts and install the supplied 14mm x 60mm bolts in the hitch as shown in **Photo 18**. Do not tighten at this time.
15. Install the 1" tall body pucks as shown above the frame, under the rear bumper mounts to move the bumper up. Secure with the supplied 14mm x 60mm bolts. Do not tighten at this time. **See Photo 19.**
16. Align bumper where the bumper is spaced equally on both sides and tighten the 14mm bolts using a 22mm socket / wrench and the factory bolts using a 18mm socket / wrench.
17. Reconnect battery cable and tighten.



POST INSTALLATION INSTRUCTIONS

1. Check all fasteners for proper torque. Check to ensure for adequate clearance between all rotating, mobile, fixed, and heated members. Test and inspect brake system.
2. On some vehicles the front lower skirting will need to be trimmed if using certain wheel /tire combinations and with heavy offset wheels. Trim only as needed.
3. Activate four wheel drive system and check front hubs for engagement.
4. Perform head light check and adjustment to proper settings.
5. All kit components must be retightened at 500 miles and then every three thousand miles after installation. Periodically check all hardware for tightness.
6. Install "Warning to Driver" decal on sun visor.

TOP

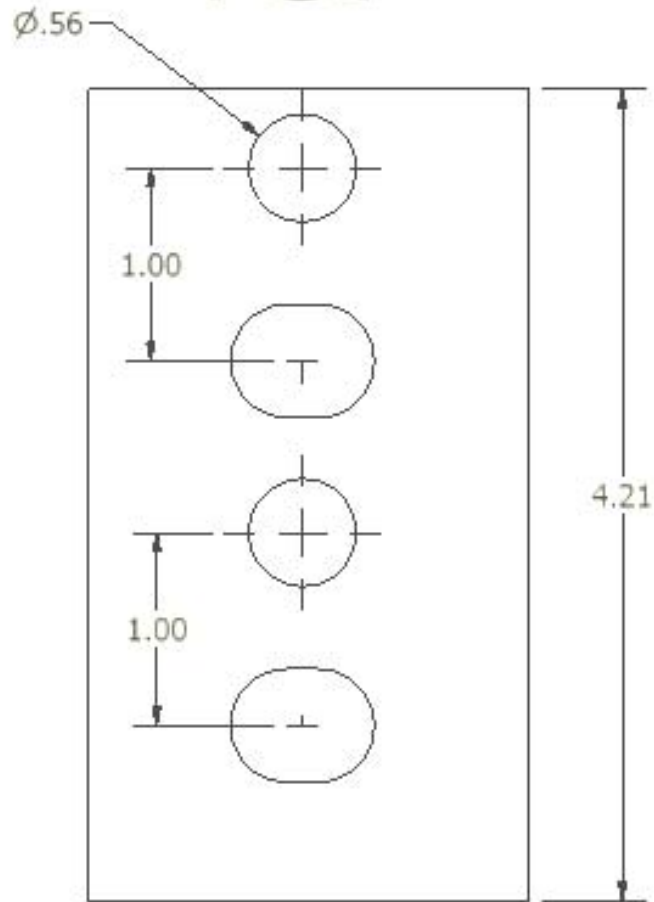

REAR BUMPER DRILLING TEMPLATE